

Nest VT™ クローズド・システム

VITRIFICATION DEVICE

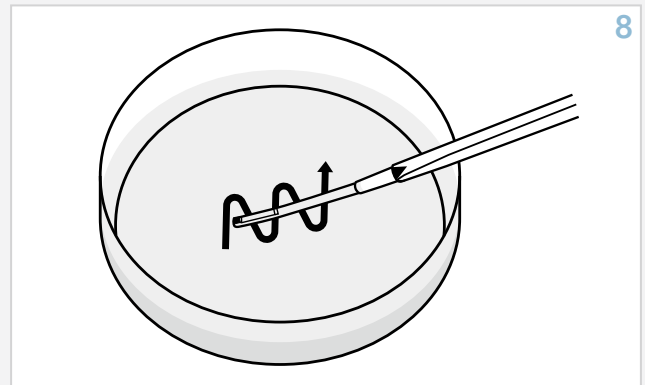
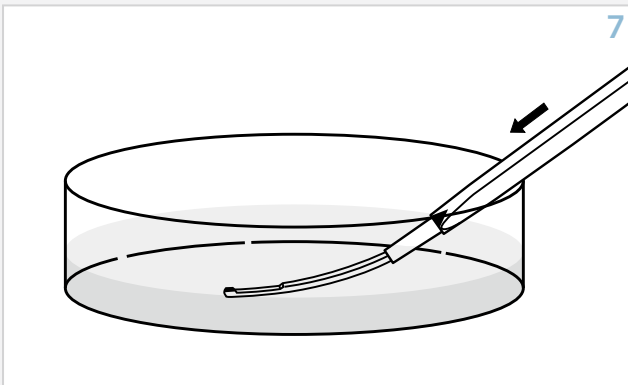
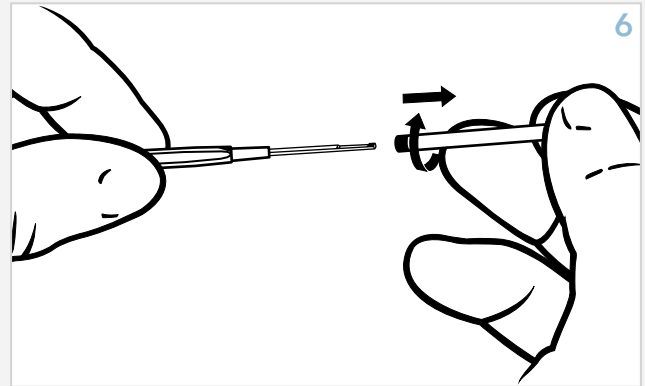
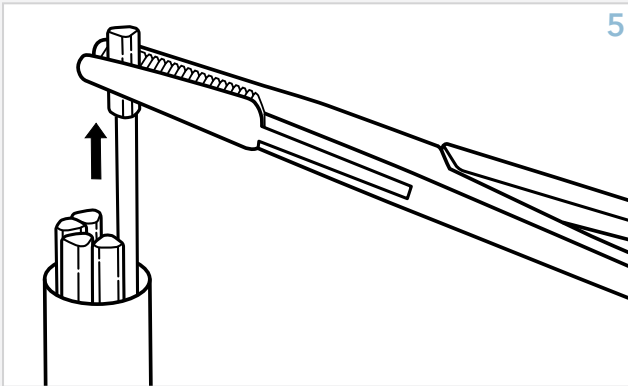
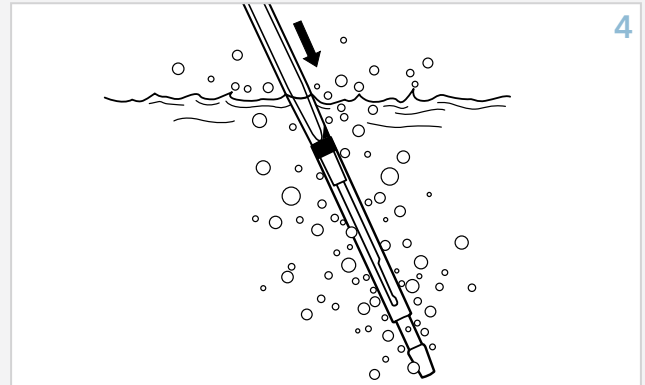
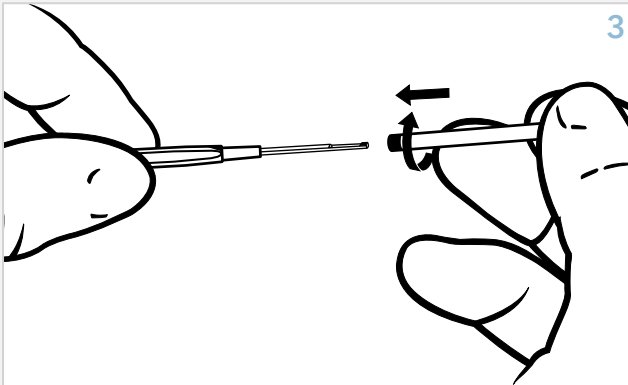
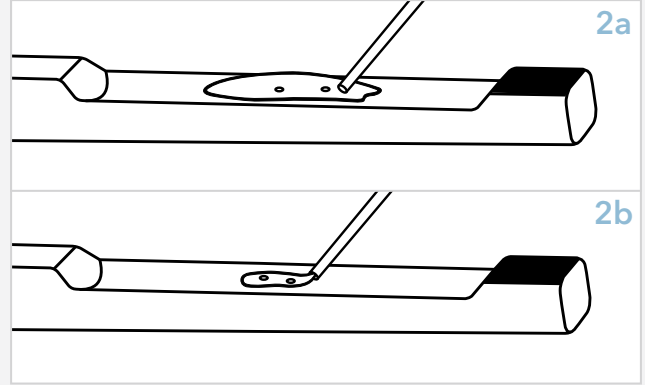
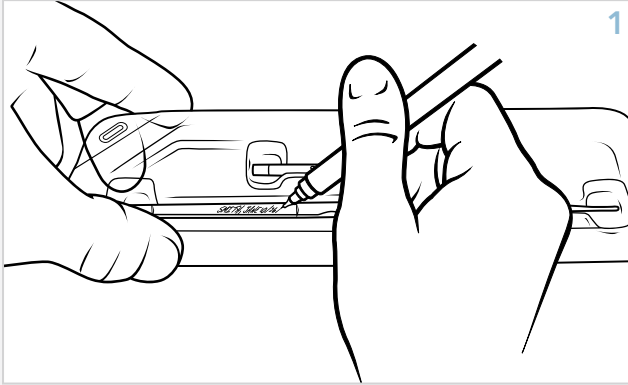

輸入元
クックメディカルジャパン合同会社
〒164-0001 東京都中野区中野4-10-1
中野セントラルパークイースト
TEL: 03-6853-9470
cookmedical.co.jp